

Installation, Setup & Operating Guide | Warranty

Model Number | L15V26D | LCD-TV / Monitor



RECORD YOUR MODEL NUMBER
(For future reference)

The model and serial number of your TV are located on the back of the TV cabinet. For convenience, we suggest that you record those numbers here:

MODEL NO. _____

SERIAL NO. _____



CAUTION
RISK OF ELECTRIC SHOCK
DO NOT OPEN



WARNING :

TO REDUCE THE RISK OF ELECTRIC SHOCK DO NOT REMOVE COVER (OR BACK). NO USER SERVICEABLE PARTS INSIDE. REFER SERVICING TO QUALIFIED SERVICE PERSONNEL.



The lightning flash with arrowhead symbol, within an equilateral triangle, is intended to alert the user to the presence of uninsulated "dangerous voltage" within the product's enclosure that may be of sufficient magnitude to constitute a risk of electric shock to persons.



The exclamation point within an equilateral triangle is intended to alert the user to the presence of important operating and maintenance (servicing) instructions in the literature accompanying the appliance.

WARNING :

TO PREVENT FIRE OR SHOCK HAZARDS, DO NOT EXPOSE THIS PRODUCT TO RAIN OR MOISTURE.

NOTE TO CABLE/TV INSTALLER:

This reminder is provided to call the cable TV system installer's attention to Article 820-40 of the National Electric Code (U.S.A.). The code provides guidelines for proper grounding and, in particular, specifies that the cable ground shall be connected to the grounding system of the building, as close to the point of the cable entry as practical.

REGULATORY INFORMATION:

This equipment has been tested and found to comply with the limits for a Class B digital device, pursuant to Part 15 of the FCC Rules. These limits are designed to provide reasonable protection against harmful interference when the equipment is operated in a residential installation. This equipment generates, uses and can radiate radio frequency energy and, if not installed and used in accordance with the instruction manual, may cause harmful interference to radio communications. However, there is no guarantee that interference will not occur in a particular installation. If this equipment does cause harmful interference to radio or television reception, which can be determined by turning the equipment off and on, the user is encouraged to try to correct the interference by one or more of the following measures:

- Reorient or relocate the receiving antenna.
- Increase the separation between the equipment and receiver.
- Connect the equipment into an outlet on a circuit different from that to which the receiver is connected.
- Consult the dealer or an experienced radio/TV technician for help.

Any changes or modifications not expressly approved by the party responsible for compliance could void the user's authority to operate the equipment.

CAUTION: Do not attempt to modify this product in any way without written authorization from Zenith Electronics Corporation. Unauthorized modification could void the user's authority to operate this product.

COMPLIANCE: The responsible party for this device compliance is:

Zenith Electronics Corporation

1-201-816-2000

Marked and Distributed in the United States by LG Electronics U.S.A., Inc.

1000 Sylvan Avenue, Englewood Cliffs, NJ 07632

<http://www.zenith.com>

IMPORTANT SAFETY INSTRUCTIONS

Important safeguards for you and your new product

Your product has been manufactured and tested with your safety in mind. However, improper use can result in potential electrical shock or fire hazards. To avoid defeating the safeguards that have been built into your new product, please read and observe the following safety points when installing and using your new product, and save them for future reference.

Observing the simple precautions discussed in this booklet can help you get many years of enjoyment and safe operation that are built into your new product.

This product complies with all applicable U.S. Federal safety requirements, and those of the Canadian Standards Association.

1. Read Instructions

All the safety and operating instructions should be read before the product is operated.

2. Follow Instructions

All operating and use instructions should be followed.

3. Retain Instructions

The safety and operating instructions should be retained for future reference.

4. Heed Warnings

All warnings on the product and in the operating instructions should be adhered to.

5. Cleaning

Unplug this product from the wall outlet before cleaning. Do not use liquid cleaners or aerosol cleaners. Use a damp cloth for cleaning.

6. Water and Moisture

Do not use this product near water - for example, near a bath tub, wash bowl, kitchen sink, or laundry tub, in a wet basement, or near a swimming pool.

7. Accessories, Carts, and Stands

Do not place this product on an unstable cart, stand, tripod, bracket, or table. The product may fall, causing serious injury to a child or adult, and serious damage to the product. Use only with a cart, stand, tripod, bracket, or table recommended by the manufacturer, or sold with the product. Any mounting of the product should follow the manufacturer's instructions, and should use a mounting accessory recommended by the manufacturer.

8. Transporting Product

A product and cart combination should be moved with care. Quick stops, excessive force, and uneven surfaces may cause the product and cart combination to overturn.

9. Attachments

Do not use attachments not recommended by the product manufacturer as they may cause hazards.

10. Ventilation

Slots and openings in the cabinet are provided for ventilation and to ensure reliable operation of the product and to protect it from overheating, and these openings must not be blocked or covered. The openings should never be blocked by placing the product on a bed, sofa, rug, or other similar surface. This product should not be placed in a built-in installation such as a bookcase or rack unless proper ventilation is provided or the manufacturer's instructions have been adhered to.

11. Power Sources

This product should be operated only from the type of power source indicated on the marking label. If you are not sure of the type of power supply to your home, consult your product dealer or local power company. For products intended to operate from battery power, or other sources, refer to the operating instructions.

12. Power-Cord Polarization

This product is equipped with a three-wire grounding type alternating-current line plug (a plug having one blade wider than the other). This plug will fit into the power outlet only one way. This is a safety feature. If you are unable to insert the plug fully into the outlet, contact your electrician to replace your obsolete outlet. Do not defeat the safety purpose of the polarized plug.

13. Power-Cord Protection

Power-supply cords should be routed so that they are not likely to be walked on or pinched by items placed upon or against them, paying particular attention to cords at plugs, convenience receptacles, and the point where they exit from the product.



PORTABLE CART WARNING

(Continued on next page)

IMPORTANT SAFETY INSTRUCTIONS

(Continued from previous page)

14. Outdoor Antenna Grounding

If an outside antenna or cable system is connected to the product, be sure the antenna or cable system is grounded so as to provide some protection against voltage surges and built-up static charges. Article 810 of the National Electrical Code (U.S.A.), ANSI/NFPA 70 provides information with regard to proper grounding of the mast and supporting structure, grounding of the lead-in wire to an antenna discharge unit, size of grounding conductors, location of antenna-discharge unit, connection to grounding electrodes, and requirements for the grounding electrode.

Example of Grounding According to National Electrical Code Instructions

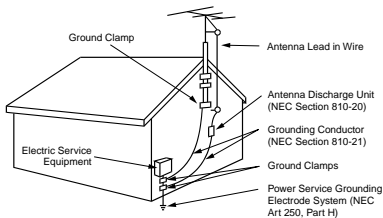

NEC - National Electrical Code

15. Lightning

For added protection for this product (receiver) during a lightning storm, or when it is left unattended and unused for long periods of time, unplug it from the wall outlet and disconnect the antenna or cable system. This will prevent damage to the product due to lightning and power-line surges.

16. Power Lines

An outside antenna system should not be located in the vicinity of overhead power lines or other electric light or power circuits, or where it can fall into such power lines or circuits. When installing an outside antenna system, extreme care should be taken to keep from touching such power lines or circuits as contact with them might be fatal.

17. Overloading

Do not overload wall outlets and extension cords as this can result in a risk of fire or electric shock.

18. Object and Liquid Entry

Never push objects of any kind into this product through openings as they may touch dangerous voltage points or short-out parts that could result in a fire or electric shock. Never spill liquid of any kind on the product.

19. Servicing

Do not attempt to service this product yourself as opening or removing covers may expose you to dangerous voltage or other hazards. Refer all servicing to qualified service personnel.

20. Damage Requiring Service

Unplug this product from the wall outlet and refer servicing to qualified service personnel under the following conditions:

- If the power-supply cord or plug is damaged.
- If liquid has been spilled, or objects have fallen into the product.
- If the product has been exposed to rain or water.
- If the product does not operate normally by following the operating instructions. Adjust only those controls that are covered by the operating instructions as an improper adjustment of other controls may result in damage and will often require extensive work by a qualified technician to restore the product to its normal operation.
- If the product has been dropped or the cabinet has been damaged.
- If the product exhibits a distinct change in performance.

21. Replacement Parts

When replacement parts are required, be sure the service technician has used replacement parts specified by the manufacturer or have the same characteristics as the original part. Unauthorized substitutions may result in fire, electric shock, or other hazards.

22. Safety Check

Upon completion of any service or repairs to this product, ask the service technician to perform safety checks to determine if the product is in proper operating condition.

23. Wall or Ceiling Mounting

The product should be mounted to a wall or ceiling only as recommended by the manufacturer. The product may slide or fall, causing serious injury to a child or adult, and serious damage to the product.

24. Heat

The product should be situated away from heat sources such as radiators, heat registers, stoves, or other products (including amplifiers) that produce heat.

CONTENTS

INDEX

Before operating the TV, please read this manual carefully.

1	Safety Warnings	2
	Important Safety Instructions	3
	Controls	6
	Remote Control:	
	Installing Batteries/ Operation	10
	TV Overview	11
2	Antenna/Cable Connections	13
	VCR Connection and Viewing Setup	15
	External Equipment Connections	16
	DVD Player Connections	17
	DTV (Set-top box) Connections	18
	PC/Computer Connections	19
	PC Mode Functions Check	21
3	Turning the TV On	22
	TV Mode Menus	23
	Menu Language Selection	24
	Auto Programming:	
	Finding/Erasing channels	25
	Favorite Channel Memory	27
4	Clock Setup	28
	Off Timer Setup	29
	On Timer Setup	30
	Sleep Timer Setup	31
5	Video/Picture Setup	32
	Audio/Sound Setup	35
6	Closed Captions	41
	Parental Control	44
	Auto Off	47
	Key lock	48
7	Maintenance	49
	Product Specifications	50
	Troubleshooting CheckList	51
	Your Zenith Limited Warranty	Back cover

Controls

Front of the TV

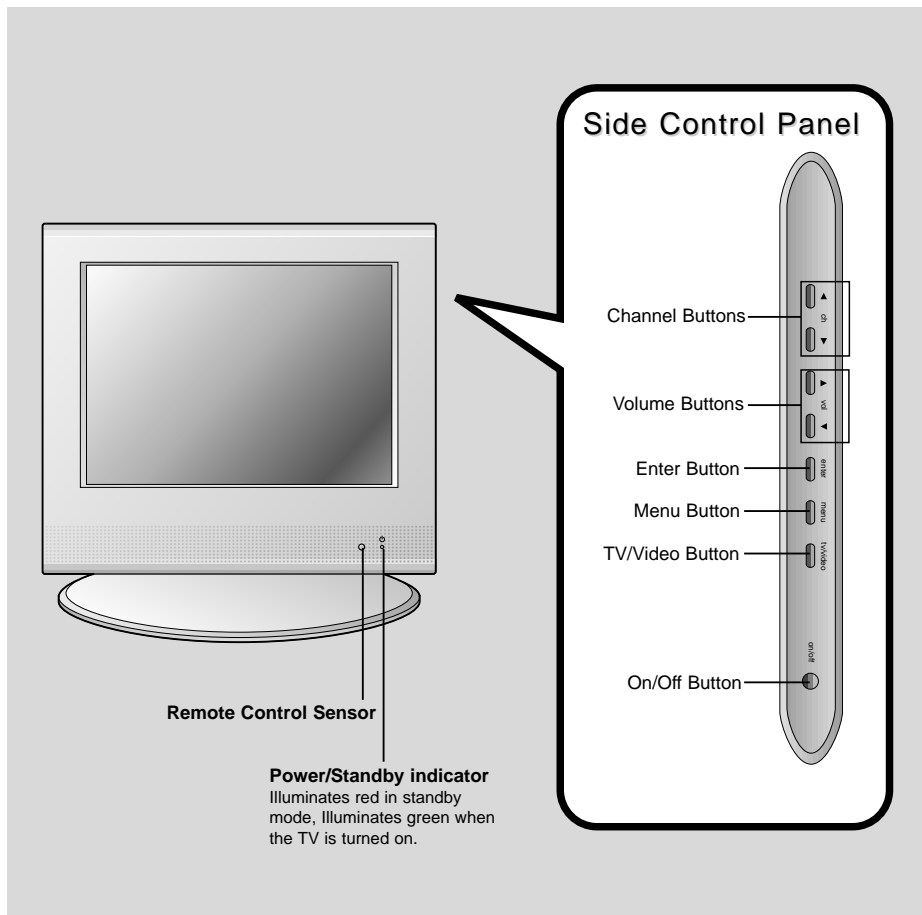

Back of the TV

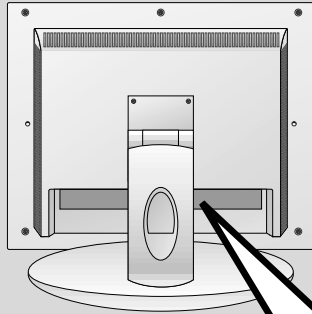

Connection Panel

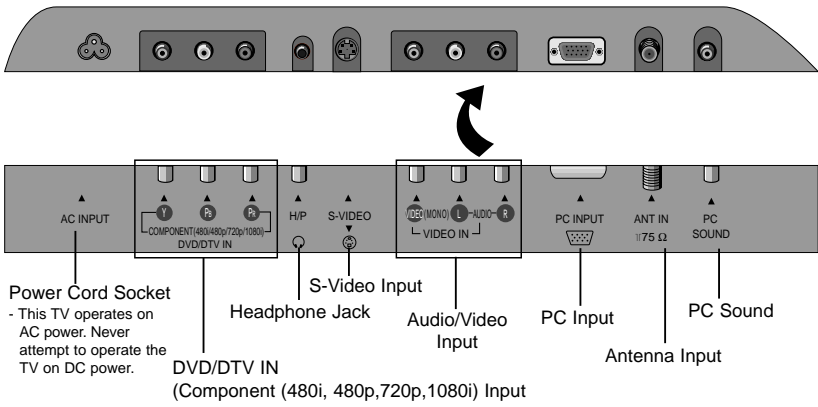

Remote Control Buttons

▶ PAGE 32

▶ PAGE 39

▶ PAGE 27

▶ PAGE 25

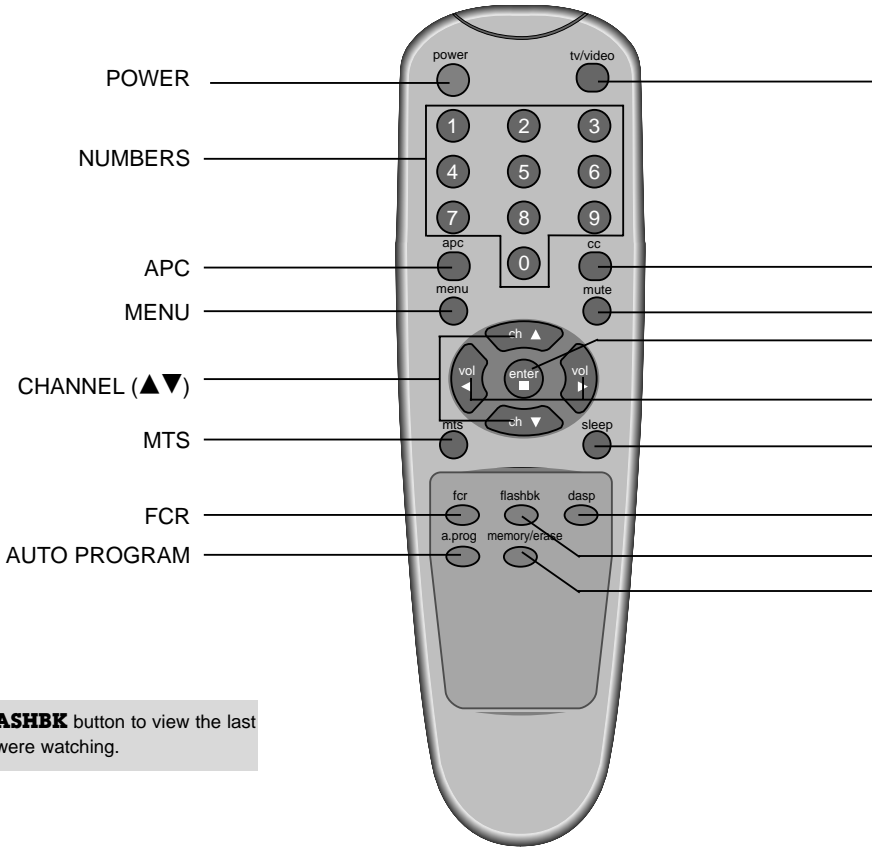

- Press the **FLASHBK** button to view the last program you were watching.

TV/VIDEO

PAGE 15~19

CLOSED CAPTIONS

PAGE 42

MUTE

PAGE 40

ENTER

VOLUME (◀▶)

SLEEP TIMER

PAGE 31

DASP

PAGE 35

FLASHBK

MEMORY/ERASE

PAGE 26

TV/VIDEO Button on Remote Control



- Each press of this button changes the viewing source as indicated below.

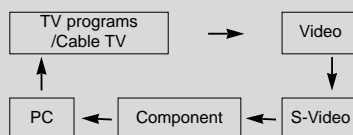

- **Video, S-video, Component, PC**
Select each mode for watching the corresponding external equipment.

Remote Control: Installing Batteries/Operation

Installing Batteries

- 1 Pull the battery cover upward in the direction shown by the arrow and remove it.

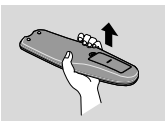

- 2 Insert the batteries with correct polarity, match "+" and "-".

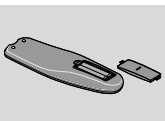

- 3 Replace the battery compartment cover.

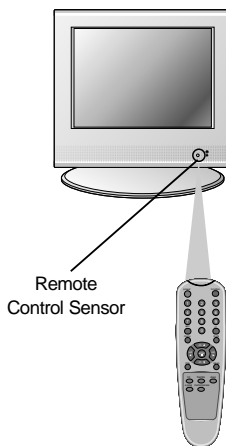
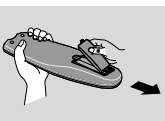

- Install two AAA, 1.5V batteries. Don't mix used batteries with new batteries.
- Remove batteries when you won't use the remote control for a long time. Liquid leakage from batteries may damage the remote.

Notes For Using Remote Control

Make sure there are no objects between the remote control and its sensor.



Don't place the remote control near a heater or in a damp place. A strong impact on remote control may damage it.



Signal from the remote control may be disturbed by sun light or other strong light. In this case, darken the room.

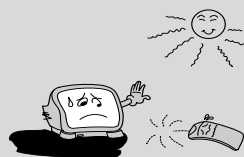

Accessories



Remote control

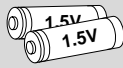

AAA
Batteries

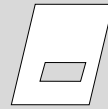

Operating guide



Power cord

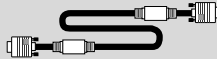

PC signal cable



PC sound cable



Tie bands
- Arrange the wires
with the tie band.



VESA standard mounting interface
- If you intend to mount the TV to a wall,
attach this plate to the back of the TV.

Adjusting the TV Viewing Angle

- You can adjust the angle of the TV between -3° and 15° (Range: $-3^{\circ}\pm 3$ and $15^{\circ}\pm 3^{\circ}$).

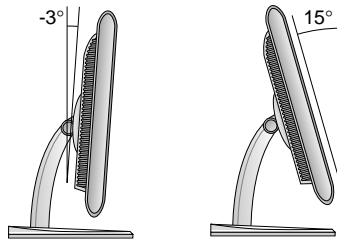

Notes

- If the TV feels cold to the touch, there may be a small "flicker" when turned on. This is normal, there is nothing wrong with TV.
- Some dot defects may appear on the screen, like red, green or blue spots. However, this will have no adverse effect on the monitor's performance.
- Avoid touching the LCD screen or holding your finger(s) against it for long periods of time. Doing so may produce some temporary distortion effects on the screen.

Antenna/Cable Connections

- For optimum picture quality, adjust antenna direction.

Connecting to an Inside Antenna Setup

- Typical wall antenna jack used in apartment buildings, connect the antenna cable as shown below. (Use the correct type of antenna cable for the type of wall antenna jack.)

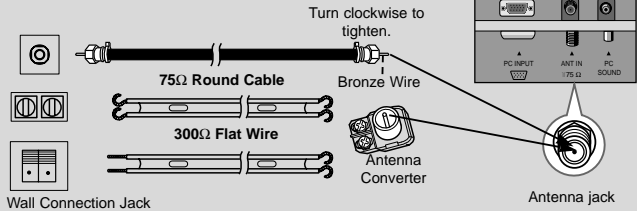
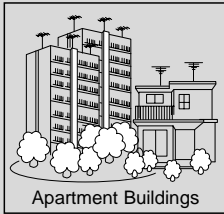

INSTALLATION



- If you have a 75Ω round cable, insert the bronze wire and then tighten the connection nut. If you have a 300Ω flat wire, connect the twisted wire to the antenna converter and then connect the converter to the antenna jack on the TV.
- When using 75Ω round cable, do not bend the bronze wire. Doing so may cause poor picture quality.

Connecting to an Outdoor Antenna Setup

- This type of antenna is commonly used in single family dwellings.

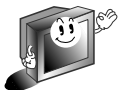
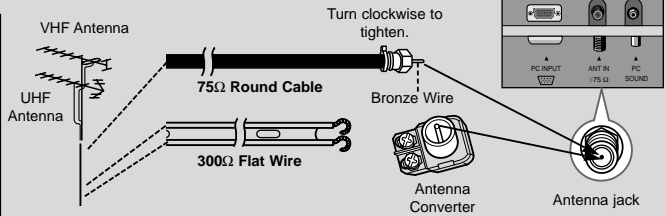
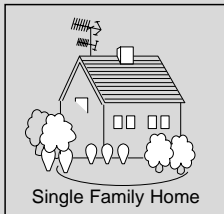

- In poor signal areas, to get better picture quality, install the antenna as shown to the right.
- If antenna is split for two TVs, use signal splitter for connection.

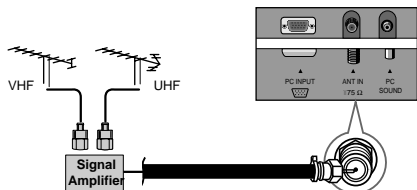

Antenna/Cable Connection and Viewing Setup

- After subscribing to a local cable TV service and installing a converter, you can watch cable TV programming.

Cable TV Connections

1 Connections

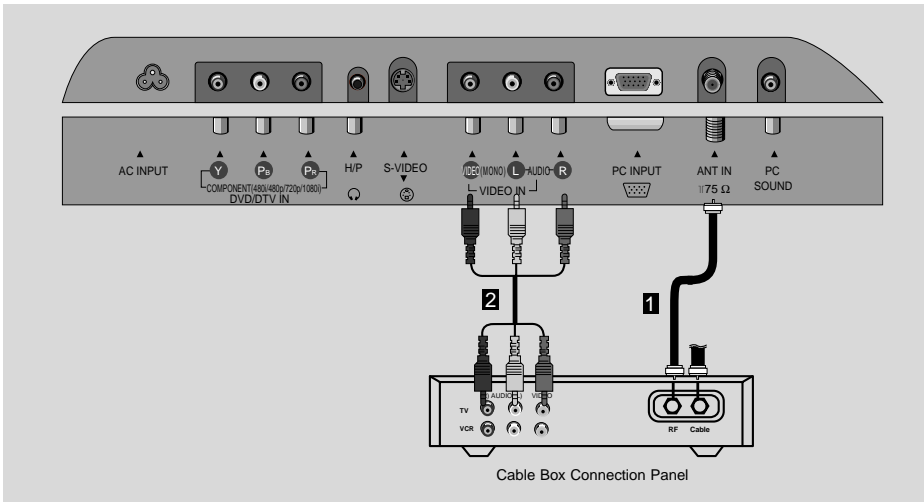

2 Viewing Setup

- Use the **tv/video** button on the remote control to select TV (Ant In.) or Video source, depending on connection setup: 1 or 2.
 - Connection 1: Set cable box switch to 3 or 4 and then tune TV to the same channel number.
 - Connection 2: Select VIDEO source input to use Audio/Video In connections.
- Select channels with the cable box.

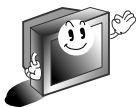

- For further cable TV information, contact a local cable service provider.

VCR Connection and Viewing Setup

- In Video mode, TV automatically reverts to TV mode if the fcr button or flashbk buttons are pressed.
- See following pages to connect to other A/V external equipment to input jacks on the TV.

Connecting a VCR

1 Connections

- Connect the audio/video output jacks on VCR to the corresponding input jacks on the TV.

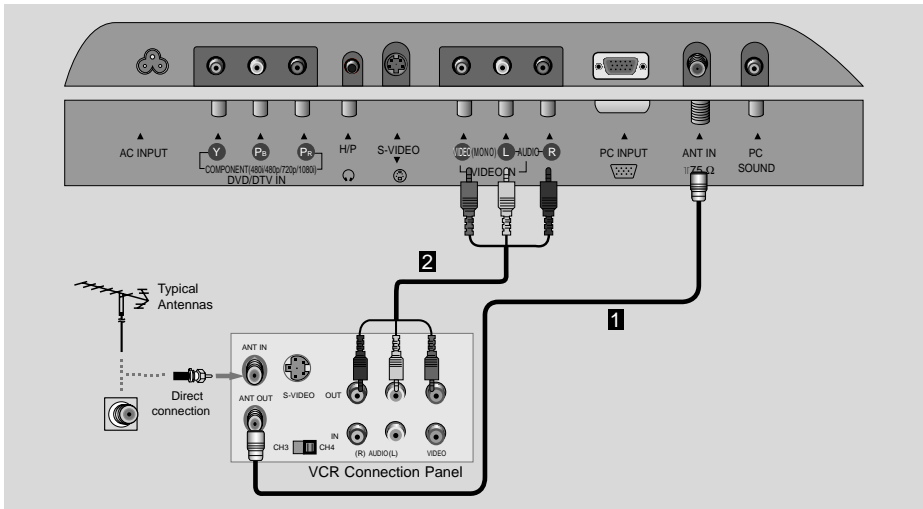

2 Viewing Setup

Watching TV programs

Turn the TV on and tune to a channel.

Watching VCR

- Use **tv/video** button on the remote control to select TV (Ant In.) or Video source, depending on connection setup: 1 or 2.
 - Connection 1: Set VCR switch to 3 or 4 and then tune TV to the same channel number.
 - Connection 2: Select VIDEO source input to use Audio/Video In connections.
- Insert a video tape into the VCR and press the PLAY button.

External Equipment Connections

Watching External A/V Source

1 Connections

- Connect the audio/video output jacks on the external A/V equipment to the corresponding input jacks on the TV.

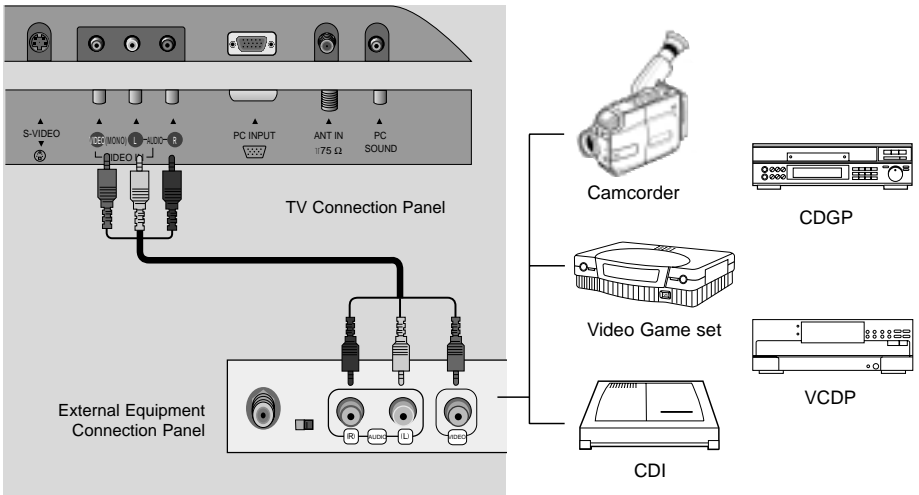

2 Viewing Setup

- Turn on the external A/V equipment.
- Turn the TV on and use the **tv/video** button to select Video source.

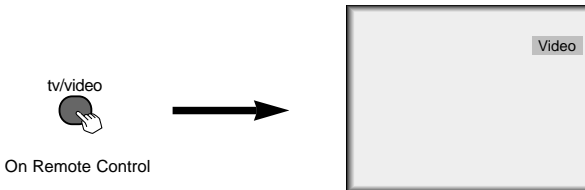

DVD Player Connections

- Connect DVD/DTV output jacks to TV's COMPONENT (480i/480p/720p/1080i), Y, Pb, Pr jacks, or S-video jack. Connect DVD/DTV audio output jacks to right and left input jacks on TV.

1 Connections

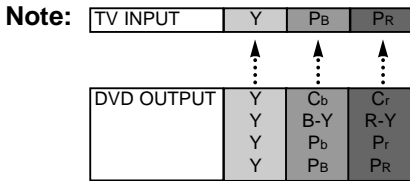
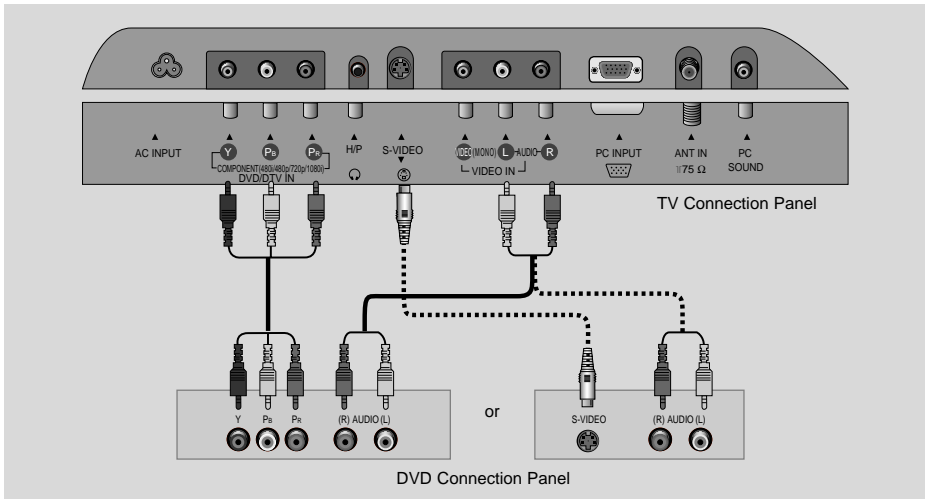

2 Viewing Setup

- Turn on the DVD player.
- Turn the TV on and use **tv/video** button to select Component source.
- See DVD/DTV user's manual for operating instructions.

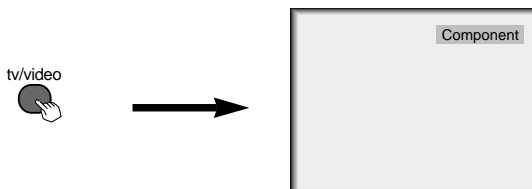

DTV (Set-top Box) Connections

- Connect DVD/DTV output to COMPONENT(480i/480p/720p/1080i), Y, Pb, Pr jack inputs on the TV. Connect DTV L/R audio outputs to the TV's AUDIO L/R input jacks.
- Note: A DTV set-top box is required to receive DTV programming.

1 Connections

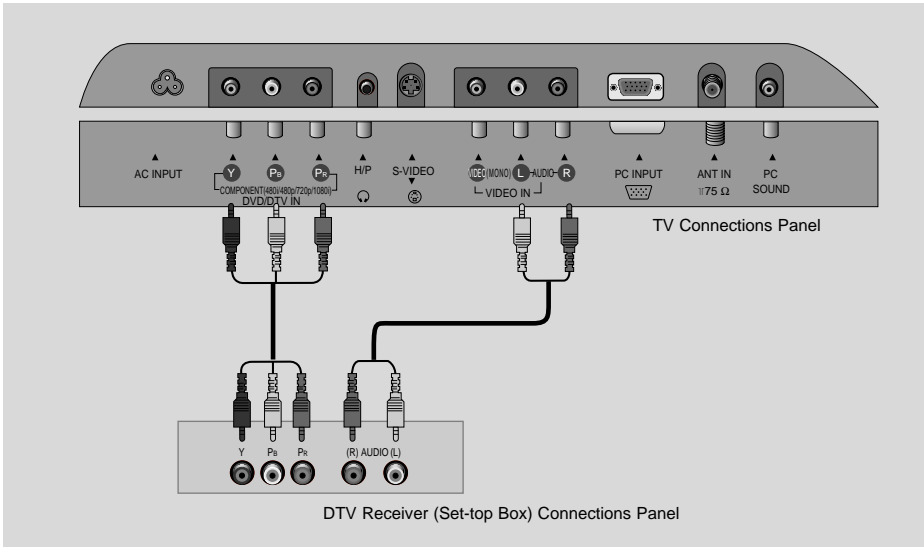

2 Viewing Setup

- Turn on the DTV receiver (Set-top Box).
- Turn the TV on and use **tv/video** button to select Component source.

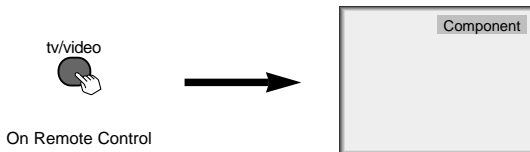

PC/Computer Connections (using TV as a Monitor)

- After setup, be sure to select RGB-PC to see the PC image on TV screen.

1 Connections

- Set the monitor output resolution on the PC before connecting to the TV. See the next page.
- Connect the TV to the PC with the PC cable.
- Connect the PC audio output to the TV's PC SOUND input.

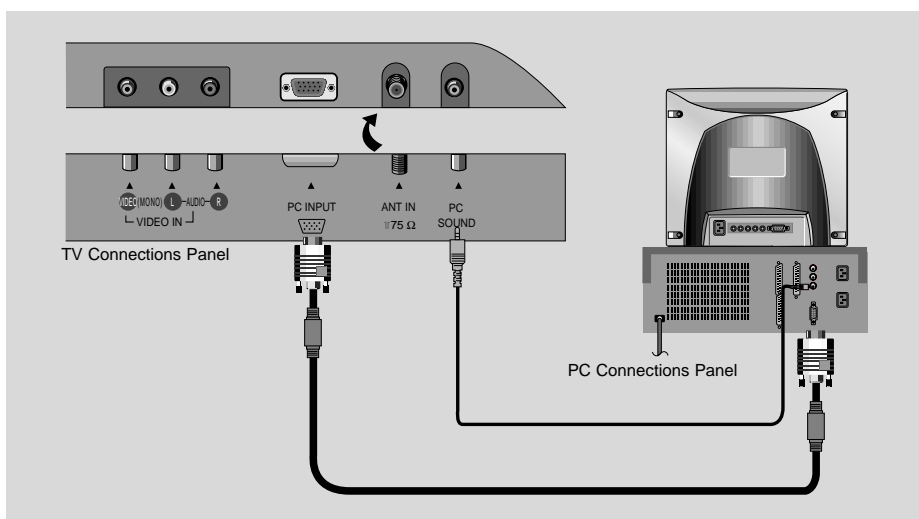

2 Viewing Setup

- Turn on the PC/Computer.
- Turn the TV on and use **tv/video** button to select PC source.



On Remote Control



Displayable Monitor Output Format Specifications

MODE	Resolution	Horizontal Frequency (KHz)	Vertical Frequency (Hz)
VGA	640x400	37.9KHz	85Hz
	640x480	31.5KHz	60Hz
	640x480	35.0KHz	67Hz
	640x480	37.9KHz	72Hz
	640x480	37.5KHz	75Hz
	640x480	43.3KHz	85Hz
SVGA	800x600	35.2KHz	56Hz
	800x600	37.9KHz	60Hz
	800x600	48.1KHz	72Hz
	800x600	46.9KHz	75Hz
	800x600	53.7KHz	85Hz
(MAC)	832x624	49.7KHz	75Hz
XGA	1024x768	48.4KHz	60Hz
	1024x768	56.5KHz	70Hz
	1024x768	60.2KHz	75Hz

Notes:

- a. For optimum picture quality, use standard XGA (1024x768) computer output at a 60Hz refresh rate. Using other formats (i.e.: VGA, SVGA, etc) or refresh rates may result in reduced picture quality. (To change the computer video output format, please refer to the operating manual for the computer you are using).
- b. If the message "**OUT OF RANGE**" appears on the screen, adjust the PC output to a format listed in the 'Displayable Monitor Output Format Specifications' chart above.
- c. The synchronization input form for Horizontal and Vertical frequencies is separate.

DPM (Display Power Management) mode

When the PC is in the power saving mode, the monitor automatically switches to DPM mode.

PC Mode Functions Check

- After setup, be sure to select PC source to see the PC image on TV screen.

- 1 Use the **menu** button to display the available menu shown below.

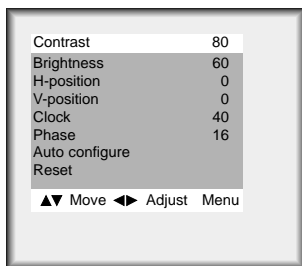

- H-position/V-position
Adjusts picture left/right and up/down.
The adjustment ranges of H-Position is -100~+100.
(Based on the input mode, the adjustment range may change.)
- Clock
Minimizes any vertical bars or stripes appearing on the screen background.
The adjustment range is 0~80. (Based on the input mode, the adjustment range may change.)
- Phase
Remove any horizontal noise and clear up or sharpen the character images.
The range adjustment is 0~31. (Based on the input mode, the adjustment range may change.)
- Auto-figure
Automatically adjusts the screen position, clock, and clock phase.
(The displayed image will disappear for a few seconds while Auto-configuration is in progress.)
- Reset
Returns to the default settings programmed at the factory; default settings cannot be changed.

Turning the TV On

TV Operation Overview

- 1 First, connect antenna cable and power cord correctly. At this moment, the TV is switched to standby mode.
 - In standby mode, press the **power**, **ch** (▲,▼), **tv/video** or **number** buttons on the remote control or **ch** (▲,▼), **tv/video** or **on/off** on the TV side panel to turn it on fully.
- 2 Select the viewing source by pressing **tv/video** repeatedly.
 - Note: See page 25 if you have not auto programmed the TV to receive channels in your local broadcast area.
- 3 After viewing, press the **power** button on the remote control or **on/off** on the TV side panel. The TV screen goes dark and it reverts to standby mode.

Watching TV Programs

- 1 Press **power** on the remote control to turn the TV on.
- 2 Use the channel (▲,▼) or number buttons to select a channel to view.
- 3 Adjust Volume level.

- Volume (▶) button increases the sound level.
- Volume (◀) button decreases the sound level.



- If you will be away on vacation, disconnect the power plug from the wall power outlet.

TV Mode Menus

- 1 Press the **menu** button repeatedly to display the available menus shown below.

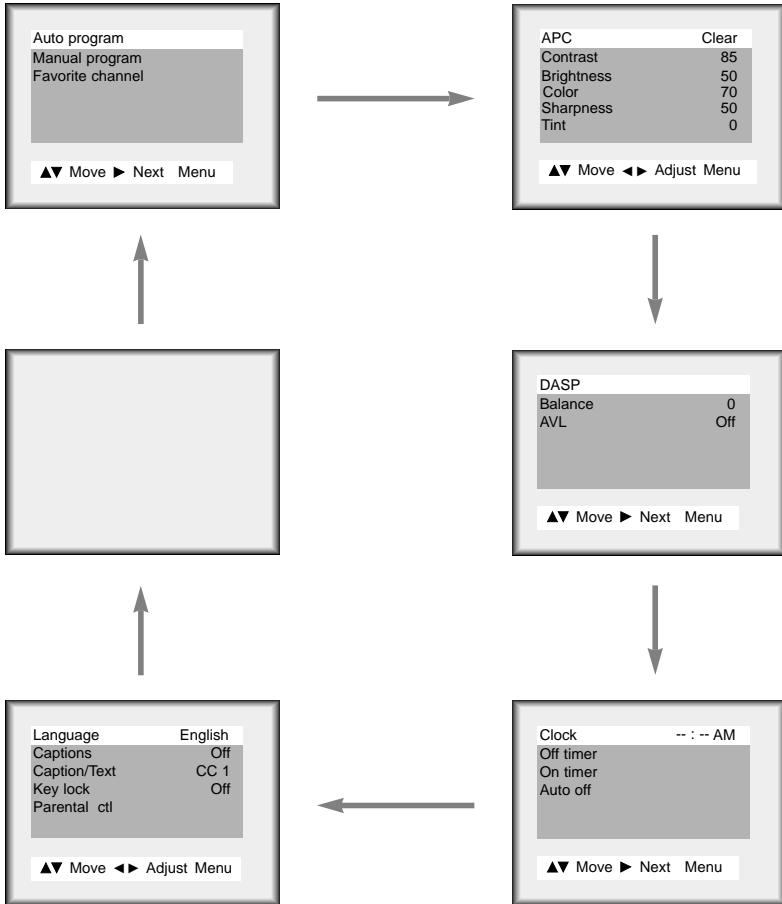

- 2 Use the channel (▲,▼) buttons to select a menu option.

Menu Language Selection

Language

- 1 Use the **menu** button to select the menu shown.

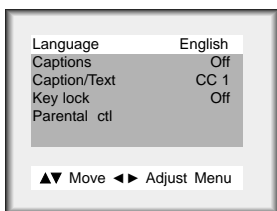

- 3 Use the volume (◀, ▶) buttons to select the language for the menus to appear in.

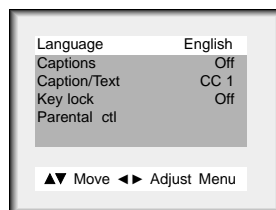

- Each press of volume (◀, ▶) buttons selects languages in the order shown below.

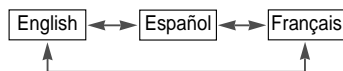

- 2 Use the channel (▲, ▼) button to select the Language option.

- 4 Press the **menu** button to save.

Auto Programming: Finding/Erasing Channels

- For Auto program to work, the programming source must be connected to the TV and the TV must be receiving programming signals either over-the-air or from a cable-type service provider.

Channel Search (Auto Programming)

1 Press the **a.prog** button on the remote control.

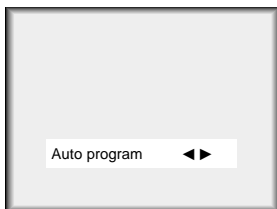

2 Press the **a.prog** or volume (◀, ▶) buttons to begin the channel search.

- Wait for auto program to complete the channel search cycle before choosing a channel. The TV scans for over-the-air channels and then channels provided by a cable service.

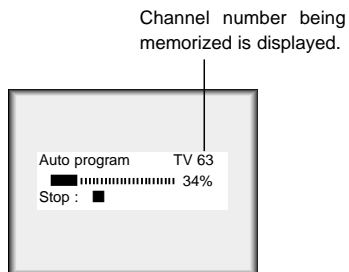

- When the channel search is complete, use the channel (▲, ▼) buttons to review the memorized channels.
- If you press the **enter** (■) button during auto programming, the function will stop and only channels found and programmed up to that time will remain in memory.
- Auto programming function can memorize only the channels which are being received at that time (some stations have limited broadcast hours).

Auto Programming: Finding/Erasing Channels

Memorizing/Erasing Channels

-Select **Memory** (to add the channel) or **Erase** (to delete the channel from memory).

1 Press the **memory/erase** button on the remote control.

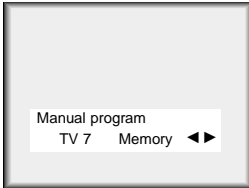

2 Use the channel (**▲, ▼**) buttons to select a channel you want to add to memory or erase and then use the **memory/erase** or volume (**◀, ▶**) buttons to select Memory (add) or Erase (delete).

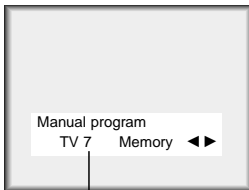

The current channel number is displayed.

- Each time you press the volume (**◀, ▶**) buttons, you toggle between Memory and Erase, as shown.



3 Press the **enter** (**■**) button to save.

- The current channel is added to Memory or Erased from the channel list.

Favorite Channel Memory

- Favorite Channel lets you quickly scan up to five channels of your choice without having to wait for the TV to scan through all the in-between channels.

- 1 Use the **menu** button to select the menu shown below.

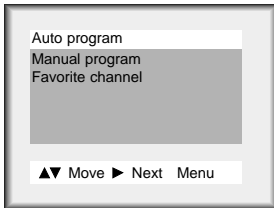

- 3 Press the volume (▶) and then use the channel (▲, ▼) buttons to select the first favorite channel position. Use the volume (◀, ▶) buttons to set the desired channel number for the first favorite channel.

i.e) To change Channel 2 to Channel 30

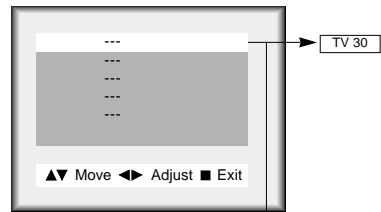

Use the volume (◀, ▶) buttons.

- 2 Use the channel (▲, ▼) buttons to select the favorite channel option.

- Repeat this step to memorize the other 4 channels.

- 4 Press the **enter** (■) button to save.



- To tune to a favorite channel, press the **fcr** (Favorite Channel Review) button repeatedly. The five favorite channels appear on the screen one-by-one.

Clock Setup

- If current time setting is wrong, reset the clock.

- 1 Use the **menu** button to select the menu shown below.

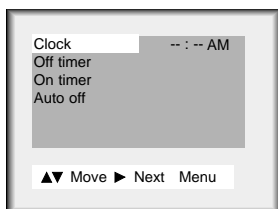

- 3 Press the volume (►) and use the channel (▲,▼) buttons to set the current minutes.

- If you hold the channel (▲) button, the minute display is changed in the sequence of 00 → 01 → 02 ...58 → 59, and changed in the reverse sequence for channel (▼) button.

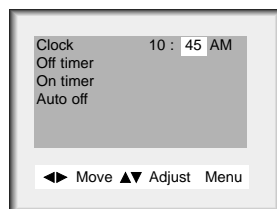

- 2 Press the volume (►) and then use the channel (▲,▼) buttons to set the current hour.

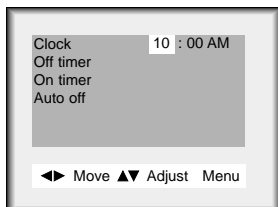

- 4 Press the **menu** button to save.

- The clock starts when you press the **menu** button.

Off Timer Setup

- Off Timer operates only if the Clock has been set to the current time.
- Off Timer overrides On Timer if they are set to the same time.

- 1 Use the **menu** button to select the menu shown below.

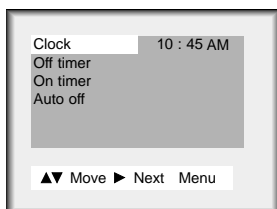

- 2 Use the channel (▲,▼) buttons to select the Off Timer option.

- 3 Press the volume (►) button and then use the channel (▲,▼) buttons to set the turn-off hour.

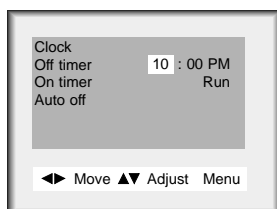

- 4 Press the volume (►) and use the channel (▲,▼) buttons to set the minutes.

- If you hold the channel (▲) button, the minute display is changed in the sequence of 00 → 01 → 02 ...58 → 59, and changed in the reverse sequence for channel (▼) button.

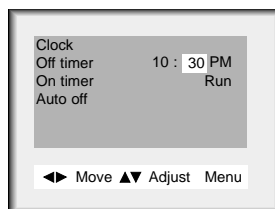

- 5 Press the volume (►) button and then use the channel (▲,▼) buttons to select Hold or Run.

- Hold, Off Timer will not work.
Run, Off Timer will work.
- Each press of channel (▲,▼) button changes the menu option as shown below.



- 6 Press the **menu** button to save.

On Timer Setup

-Timer function operates only if current time has been already set.

- 1 Use the **menu** button to select the menu shown below.

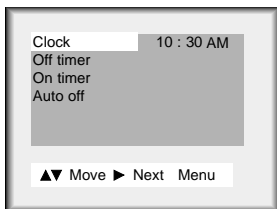

- 2 Use the channel (▲,▼) buttons to select the On Timer option.

- 3 Press the volume (▶) and then use the channel (▲,▼) buttons to set the turn-on hour.

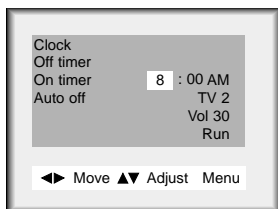

- 4 Press the volume (▶) and use the channel (▲,▼) buttons to set the minutes.

- If you hold the channel (▲) button, the minute display is changed in the sequence of 00 → 01 → 02 ...58 → 59, and changed in the reverse sequence for channel (▼) button.

- 5 Press the volume (▶) button and then use the channel (▲,▼) buttons to select the channel at turn-on.

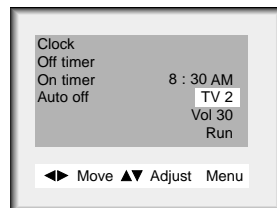

- 6 Press the volume (▶) button and then use the channel (▲,▼) buttons to select the volume you want.

- 7 Press the volume (▶) button and then use the channel (▲,▼) buttons to select Hold or Run.

- Each press of channel (▲,▼) button changes the menu option as shown below.



- 8 Press the **menu** button to save.

- On Timer setup is complete.



- Unless a button is pressed within two hours after the TV is turned on by the On Timer function, the TV will automatically turn off.
- TV must be in standby mode for the On Timer to work.

Sleep Timer Setup

- Sleep Timer turns the TV off at the preset time.

1 Use the **sleep** button to set the sleep timer.

- Each press of sleep or volume (◀, ▶) button changes the setting as shown below.

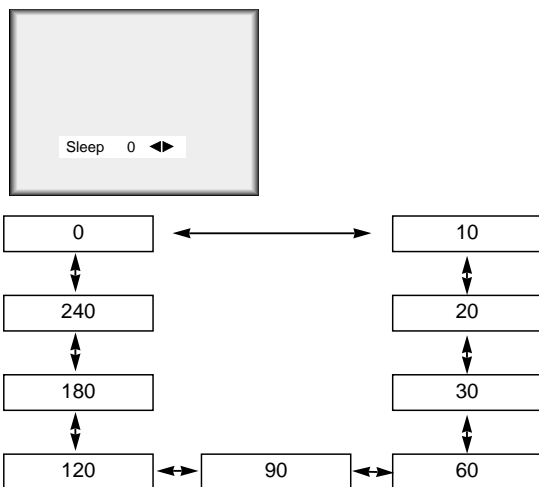

- To cancel sleep time setting, press the **sleep** button repeatedly to select Sleep 0.



- When the sleep time you want is displayed on the screen, don't press the **sleep** button again.
- To check the remaining sleep time, press the **sleep** button once.
- To change sleep time setting, press the **sleep** button repeatedly to select time setting you want.
- If you turn the TV off after setting the Sleep Timer, the setting will be erased.

Video/Picture Setup

- APC adjusts the TV for the best picture appearance.

APC (Auto Picture Control)

1 Press the **apc** button on the remote control.



2 Use the **apc** buttons or volume (◀, ▶) button to select your desired picture appearance.

- Each press of volume (◀, ▶) button selects a different picture appearance.

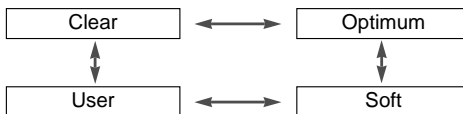

3 Press the **enter** (■) button to save.

Manual Picture Control (User Option)

1 Use the **menu** button to select the menu shown.

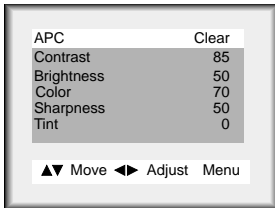

3 Use the volume (◀, ▶) button to make appropriate adjustments.



- Use the channel (▲, ▼) button to select another picture option.
- Contrast, Brightness, Sharpness and Color are adjustable from 0 to 100.
- Tint is adjustable from Red 50 to Green 50.

2 Use the channel (▲, ▼) button to select a picture option to adjust.

4 Press the **menu** button to save.



- APC is cancelled if you set User options.

Video/Picture Setup

- Fine tune the Picture appearance to your personal preference

Fine Tuning Adjustment

- 1 Use the **menu** button to select the menu shown below.

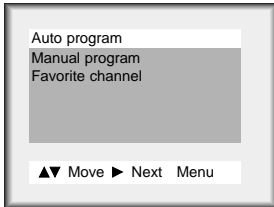

- 3 Press the volume (►) and then use the channel (▲,▼) buttons to select the Fine option.

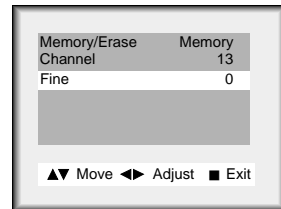

- 2 Use the channel (▲,▼) buttons to select the Manual program option.

- 4 Use the volume (◀, ►) buttons to adjust the picture appearance to your preference.

- 5 Press the **enter** (■) button to save.

Audio/Sound Setup

-DASP selects the sound appropriate for your program.

Audio Setup / DASP

- 1 Press the **dasp** button on the remote control.

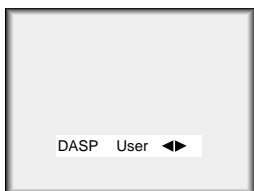

- 2 Use the **dasp** button or volume (◀, ▶) button to select the desired setting for the sound.

- Each press of volume (◀, ▶) button changes the DASP sound option as shown.

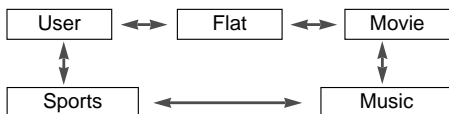

- 3 Press the **enter** (■) button to save.

Equalizer Adjustments

- 1 Use the **menu** button to select the menu shown.

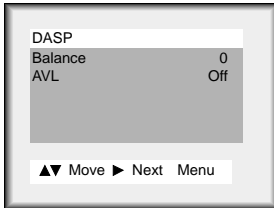

- 4 Use the volume (◀, ▶) buttons to select the band you want to adjust and then use the channel (▲, ▼) buttons to adjust the band level.

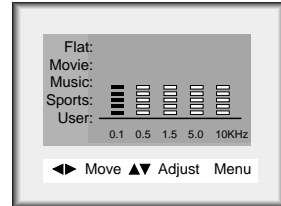

- 2 Use the channel (▲, ▼) button to select the DASP option, then press the volume (▶) button.

- 3 Use the channel (▲, ▼) button to select the User option.

- 5 Press the **menu** button to save.

Sound Balance

- 1 Use the **menu** button to select the menu shown below.

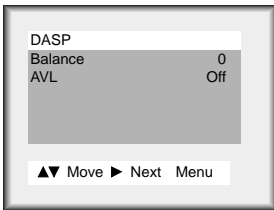

- 2 Use the channel (▲, ▼) button to select the Balance option.

- 3 Use the volume (◀, ▶) button to adjust the balance.

- Balance is preset at 0.

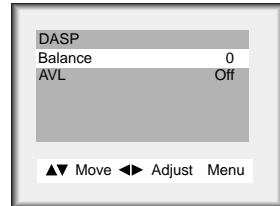

- 4 Press the **menu** button to save.

Audio/Sound Setup

- AVL maintains an equal volume level automatically even if the channel is changed.

AVL (Auto Volume Leveler)

1 Use the **menu** button to select the menu shown below.

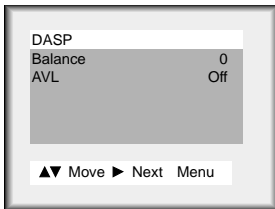

3 Use the volume (◀, ▶) buttons to select On or Off.

- Each press of volume (◀, ▶) buttons changes the menu options as shown below.



2 Use the channel (▲, ▼) buttons to select the AVL option.

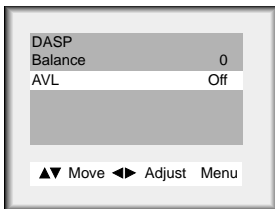

4 Press the **menu** button to save.

Selecting Bilingual Signal (Second Audio Program)

On-screen display in stereo mode: STEREO

On-screen display in bilingual mode: SAP

- Bilingual (second audio program) signal

- This signal contains the secondary language signal in addition to the primary language.
- There are primary and secondary language and stereo modes in bilingual signals.
- [MONO]: The primary language is heard from left and right speakers in mono sound.
- [STEREO]: The primary language is heard from left and right speakers in stereo sound.
- [SAP]: The secondary language is heard from both left and right speakers in mono sound.

1 Press the **mts** button on the remote control.

2 Use the **mts** button to change the audio mode.

- Each press of **mts** button changes the audio mode as shown below.

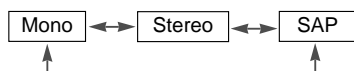

3 Press the **enter** (■) button to save.



- Select Mono sound mode if the signal is not clear or in poor signal reception areas.
- STEREO and SAP modes are available only if included on the broadcast signal.

Audio/Sound Setup

Mute

- Mute removes the speaker sound. Using mute is convenient if the user needs to answer a phone call, while viewing the TV.

1 Press the **mute** button on the remote control.



- To restore muted sound, press the **mute** button or volume (◀ ▶) buttons.
- When muted sound is restored, current volume level is displayed on the screen.

Using Headphones

- Plug headphones in to H/P jack as shown.
- Adjust sound level to a headphone using the volume (◀ ▶) buttons. While you are listening to sound through a headphone(s), TV speakers will not be heard.

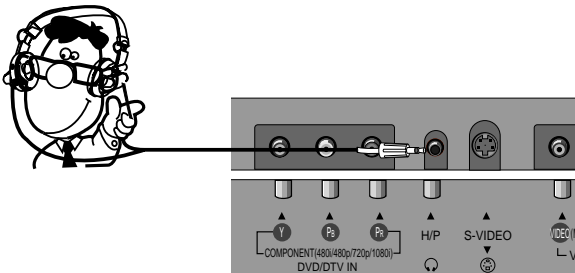

Closed Captions

Closed captioning is a process which converts the audio portion of a television program into written words which then appear as subtitles on the television screen. Closed captions allow viewers to read the dialogue and narration of television programs.

Using Closed Captions

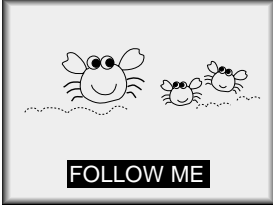

Captions are the subtitles of the dialogue and narration of television programs. For prerecorded programs, program dialogue can be arranged into captions in advance. It is possible to caption a live program by using a process called real-time captioning, which creates captions instantly. Real-time captioning is normally done by professional reporters using a machine shorthand system and computer for translation into English. Captioning is an effective system for the hearing-impaired, and it can also aid in teaching language skills.

- The picture at left shows a typical caption.

Caption Tips

- Not all TV broadcasts include closed caption signals.
- Sometimes TV stations broadcast four different caption signals on the same channel. By selecting **From CC 1 to CC 4**, you can choose which signal you view. **CC 1** is usually the signal with the captions, while **Another mode** might show demonstration or programming information.
- Your TV might not receive caption signals normally in the following situations.

1 Poor reception conditions are encountered:



- **IGNITION:**

Picture may flutter, drift, suffer from black spots, or horizontal streaking. Usually caused by interference from automobile ignition systems, neon lamps, electrical drills, and other electrical appliances.



- **GHOSTS:**

Ghosts are caused when the TV signal splits and follows two paths. One is the direct path and the other is reflected off tall buildings, hills or other objects. Changing the direction or position of the antenna may improve reception.



- **SNOW:**

If your receiver is located at the weak, fringe area of a TV signal, your picture may be marred by small dots. It may be necessary to install a special antenna to improve the picture.

2 An old, bad or illegally recorded tape is playing.

3 Strong, random signals from a car or airplane interfere with the TV signal.

4 The signal from the antenna is weak.

5 The program wasn't captioned when it was produced, transmitted, or taped.

(Continued on next page)

Closed Captions

Captions Setup

- 1 Press the **cc** button on the remote control to select Captions.



- 2 Use the **cc** button or the volume (◀▶) buttons to select On and press the **enter** (■) button.

- Each press of volume (◀▶) buttons changes the caption option as shown below.

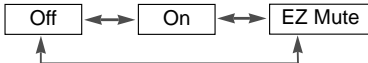

- To complete Captions Setup, see the next page.
- EZ Mute shows the selected captions option (if available on program) when the TV sound is muted.

Text Setup

Text services give a wide variety of information on all kind of subjects (ex. captioned program lists, weather forecasts, stock exchange topics, news for hearing-impaired---) on up to half of the TV screen. But not all stations offer text services, even though they might offer captioning.

- In the event you are receiving a poor signal, an empty black box may appear and disappear, even when the text mode is selected. This is a normal when receiving a poor signal.

- 1 Repeat steps 1-3 on next page.

- 2 Use the volume (◀▶) buttons to select: Text 1, Text 2, Text 3, or Text 4.

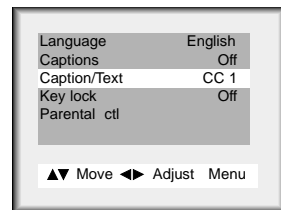

- 3 Press the **menu** button to save.

Operating Captions

- 1 Use the **menu** button to select the menu shown below.

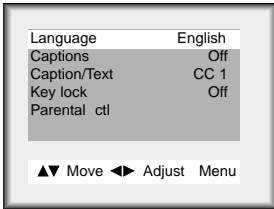

- 2 Use the channel (▲,▼) buttons to select the Caption/Text option.

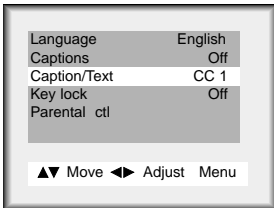

- 3 Press the volume (▶) button.

- Each time you press the volume (◀, ▶) buttons, the caption mode is changed as shown below.

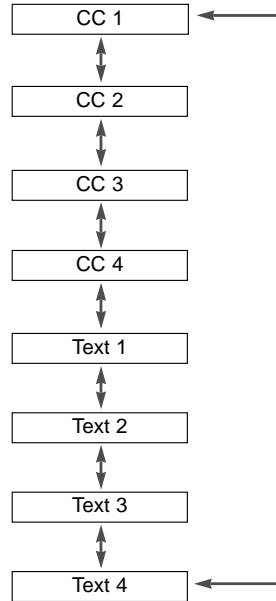

- 4 Press the **menu** button to save.

- This TV is programmed to remember the caption/text mode it was last set to, when you turn the POWER off.

Parental Control

The Parental Control Function (V-Chip) is used to block program viewing based on the ratings sent by the broadcast station. The default setting is to allow all programs to be viewed. Viewing can be blocked by the type of program and by the categories chosen to be blocked. It is also possible to block all program viewing for a time period. To use the Parental Control Function, the following must be set.

1. Ratings and categories to be blocked.
2. Number of hours to lock the television viewing control
3. Set a password
4. Enable the lock

V-Chip rating and categories

Rating guidelines are provided by broadcast stations. Most television programs and television movies can be blocked by TV Rating and/or Individual Categories. Movies that have been shown at the theaters or direct-to-video movies use the Movie Rating System (MPAA) only.

For Movies previously shown in theaters:

Movie Ratings:

- Unblocked
- G and Above (general audience)
- PG and Above (parental guidance suggested)
- PG-13 and Above (13 years and up)
- R and Above (restricted)
- NC-17 and Above (18 years and up)
- X (adult)

If you set PG-13 and Above, G and PG movies will be available; PG-13, R, NC-17, and X will be blocked.

For Television programs including made-for-TV movies:

General TV Ratings:

- Unblocked
- TV-G and Above (general audience) (individual categories do not apply)
- TV-PG and Above (parental guidance suggested)
- TV-14 and Above (14 years and up)
- TV-MA (mature audience)

Children TV Ratings:

- Unblocked
- TV-Y and Above (youth) (individual content categories do not apply)
- TV-Y7 (youth, 7 years and up)

Content Categories:

- Dialog - sexual dialogue (applies to TV-PG and Above, TV-14)
- Language - adult language (applies to TV-PG and Above, TV-14 and Above, TV-MA)
- Sex scenes - sexual situations (applies to TV-PG and Above, TV-14 and Above, TV-MA)
- Violence (applies to TV-PG and Above, TV-14 and Above, TV-MA)
- F Violence - fantasy violence (applies only to TV-Y7)

(See next page to set blocking.)

For Canadian English/French language rating system:

Canadian English language rating system:

- * C and Above (Children)
- * C8+ and Above (8 years and up)
- * G and Above (General programming. Suitable for all audiences.)
- * PG and Above (Parental guidance suggested)
- * 14+ and Above (Viewer 14 years and up)
- * 18+ (Adult programming)

Canadian French language rating system:

- * G and Above (General)
- * 8 ans+ and Above (8 years and up)
- * 13 ans+ and Above (13 years and up)
- * 16 ans+ and Above (16 years and up)
- * 18 ans+ (Adults only)

1 Use the **menu** button to select the menu shown.

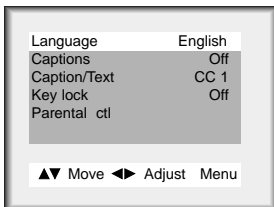

2 Use the channel (▲,▼) buttons to select the the Parental ctl option.

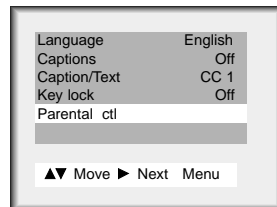

Parental Control

3 Press the volume (▶) button.

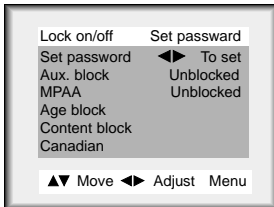

4 Use the channel (▲,▼) buttons to select the Set Password option. Then, press the volume (◀, ▶) buttons. Enter a four digit password. Enter it again when requested.

- If Parental ctrl is active, then enter the password when requested.
- The TV is set to the initial password: "0-0-0-0".

5 Use the channel (▲,▼) buttons to select the Lock on/off option. Then, press the volume (◀, ▶) buttons to select on or off.

6 Use the channel (▲,▼) buttons to select the types of blocking to be set. Use the volume (◀, ▶) buttons to select the types of ratings to block.

- Age block and Content block, and Canadian options, also have sub menus; repeat step 3 to 4 in sub menu, to set type of blocking and rating.

Press the **menu** button to return from Age block or Content block options.

Auto Off

- If there is no input signal, the TV switches to standby mode automatically after 10 minutes.

1 Use the **menu** button to select the menu shown.

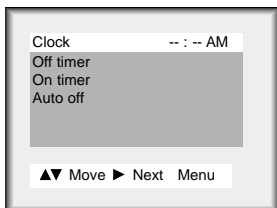

2 Use the channel (▲,▼) buttons to select the the Auto off option.

3 Use the volume (◀,▶) buttons to select On or Off.

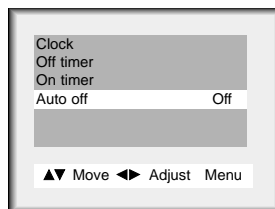

• Each press of volume (◀,▶) buttons toggles between On and Off.



4 Press the **menu** button to save.

Key Lock

- The TV can be set up so that it can only be used with the remote control.
- This feature can prevent unauthorized viewing.

1 Use the **menu** button to select the menu shown.

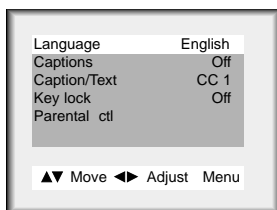

3 Use the volume (◀▶) buttons to select On or Off.

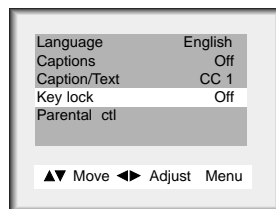

- Each press of volume (◀▶) buttons toggles between On and Off.



2 Use the channel (▲,▼) buttons to select the the Key lock option.

4 Press the **menu** button to save.



- This TV is programmed to remember which option it was last set to even if you turn the TV off.

Maintenance

Caring for your TV

Early malfunctions can be prevented. Careful and regular cleaning can extend the amount of time you will have your new TV. Be sure to turn the power off and pull out the plug before you begin any cleaning.

Screen Cleaning

1. Here's a great way to keep the dust off your screen for a while. Wet a soft cloth in a mixture of lukewarm water and a little fabric softener or dish washing detergent. Wring the cloth until it's almost dry, and then use it to wipe the screen.
2. Make sure not to put an excessive amount of water on the screen, let it air-dry before you turn on your TV.

Cabinet Cleaning

1. Use a soft cloth with a mild soap solution to wipe the cabinet.
2. Rinse the cloth and wipe the cabinet again.
3. Let the cabinet air-dry before turning your TV on.

Extended Absence



If you intend to leave your TV unused for a long time (such as a vacation), it's a good idea to unplug the power cord to protect against possible damage from lightning or power surges. If you use an antenna, you may also want to disconnect it from the back of the TV before leaving.

Product Specifications

Model	L15V26D
Horizontal size (inches)	15.2
Height (inches)	14.5
Depth (inches)	7
Weight (pounds)	16
Power requirements	AC 110-240V ~ 60Hz
Television system	NTSC
Television channels	VHF : 2 ~ 13, UHF : 14 ~ 69 Cable : 1 ~ 125
Tube	LCD Panel
Power consumption	45 W
External antenna impedance	75 Ω
Audio output	1 W + 1 W
External input ports	Power cord socket 1 Component (480i/480p/720p/1080i) input 1 set S-VIDEO input 1 Headphone jack 1 Video/Audio input set 1 PC input jack 1 PC sound jack 1 Antenna input 1
Power supply cord set	Standard North America three wire earth-grounding with flexible cord SJT type or higher type.

CAUTION: If replacement becomes necessary, replace it with an exact duplicate.
Contact any Zenith authorized service center.

Troubleshooting Checklist

SYMPTOMS

No power

No picture or sound

Poor picture but good sound

Poor reception

Lines in picture

Ghosts (multiple images)

Remote control does not work.

Cannot tune desired channel.

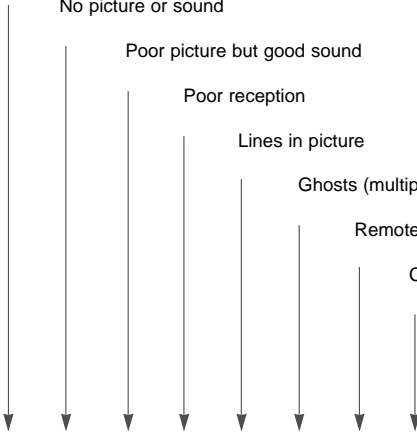
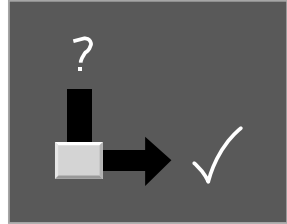

CHECK THESE THINGS

- Is power cord plugged in?
- Is television turned on?
- Check batteries in remote control.
- Try another channel (station trouble).
- Check antenna connections.
- Check for local interference.
- Adjust the antenna.
- Adjust the picture control.
- Program channels using AUTO PROGRAM.

**ZENITH ELECTRONICS CORPORATION
LCD-TV L15V26D LIMITED WARRANTY – USA**



Zenith will repair or replace your product, at Zenith's option, if it proves to be defective in material or workmanship under normal use, during the warranty period ("Warranty Period") listed below, effective from the date ("Date of Purchase") of original purchase of the product. This limited warranty is good only to the original purchaser of the product and effective only when used in the United States, excluding U.S. Territories.

<p>WARRANTY PERIOD:</p> <p>LABOR: 1 Year from the Date of Purchase.</p> <p>PARTS: 1 Year from the Date of Purchase.</p> <p>* Repaired or replaced products are warrantied for the remaining portion of the original warranty period.</p>	<p>HOW SERVICE IS HANDLED:</p> <p>Factory Service. Call 1-877-9Zenith (1-877-993-6484) (24 hours a day, 365 days per year) for instructions on getting the defective unit repaired or replaced.</p> <p>Please retain dated sales receipt and your box to return the unit to Zenith for replacement.</p> <p>Shipping charges both ways will be paid by Zenith during the Warranty Period.</p> <p>Visit our website at http://www.zenithservice.com</p>
---	---

THIS WARRANTY IS IN LIEU OF ANY OTHER WARRANTIES, EXPRESS OR IMPLIED, INCLUDING WITHOUT LIMITATION, ANY WARRANTY OF MERCHANTABILITY OR FITNESS FOR A PARTICULAR PURPOSE. TO THE EXTENT ANY IMPLIED WARRANTY IS REQUIRED BY LAW, IT IS LIMITED IN DURATION TO THE EXPRESS WARRANTY PERIOD ABOVE. ZENITH WILL NOT BE LIABLE FOR ANY INCIDENTAL, CONSEQUENTIAL, INDIRECT, SPECIAL, OR PUNITIVE DAMAGES OF ANY NATURE, EVEN IF ADVISED OF THE POSSIBILITY OF SUCH DAMAGES, INCLUDING WITHOUT LIMITATION, LOST REVENUES OR PROFITS, LOST OR CORRUPTED PROGRAMMING OR DATA, OR ANY OTHER DAMAGE WHETHER BASED IN CONTRACT, TORT, OR OTHERWISE.

Some states do not allow the exclusion or limitation of incidental or consequential damages or limitations on how long an implied warranty lasts, so the above exclusion or limitation may not apply to you. This warranty gives you specific legal rights and you may also have other rights that vary from state to state.

THIS LIMITED WARRANTY DOES NOT APPLY TO:

- Damages or operating problems that result from shipping, installation, adjustment of user controls, calibration, maintenance or failure to maintain, or separate system components; and
- Damages or operating problems that result from normal wear and tear, misuse, abuse, operation outside environmental specifications or contrary to the requirements or precautions in the Operating Guide, accident, lightning strikes or other natural causes, unauthorized modification or alteration, incorrect electrical current or voltage, signal reception or input, operating and software protocols adopted after date of manufacture or for outside the US, institutional or commercial use, or other causes not arising out of defect in material or workmanship.

The cost of repair or replacement under these excluded circumstances shall be borne by the consumer.

CUSTOMER INTERACTIVE CENTER NUMBERS:

<p>For Where to buy, Product Assistance, or Customer Assistance</p>	<p>Call 1-877-9Zenith (1-877-993-6484) (24 hours a day, 365 days per year) and select appropriate options from the menu.</p> <p>Or visit our website at http://www.zenithservice.com</p>
--	---